

KTR-30			
Type	Di +0,2	Da	Load Rating C [daN]
KTR-50x1,5.30	47,3	49,9	80
KTR-50x2,8.30	44,6	49,9	80
KTR-60x1,5.30	57,3	59,9	80

Other dimensions on request!

- ☛ Housing: Plastic
- ☛ Single Labyrinth Seal: Plastic
- ☛ Bearing RL-30
 - ☛ Bearing Shell: Steel, Hardened
 - ☛ Inner Race: Steel, Hardened
 - ☛ Ball Cage: Plastic
 - ☛ Ball: Steel

Please note: the single labyrinth seal for axis 15 mm is delivered separately and has to be locked at assembly.

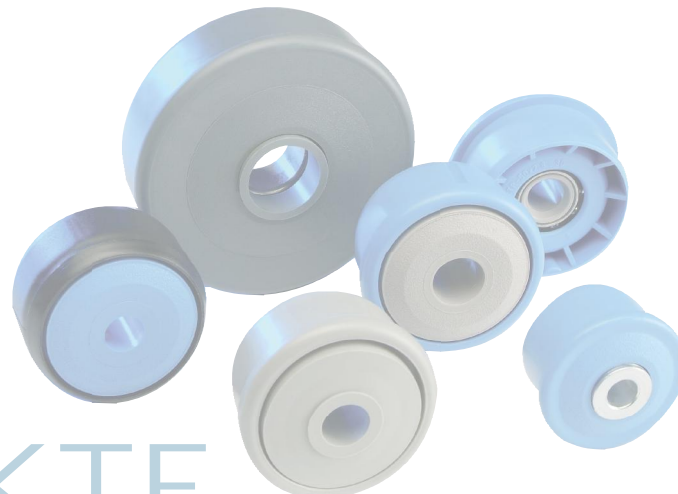

KTR-30

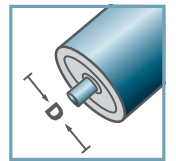

D [mm]
50 - 60

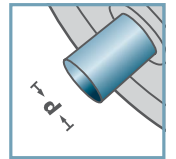

d [mm]
10; 12; 15; SW11



C [daN]
80

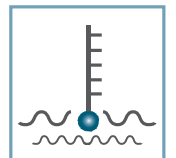

T [°C]
0° - 80°



Oil



Carton [pcs.]

ø50: 250
ø60: 200

KTR/KTE

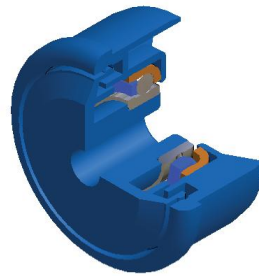
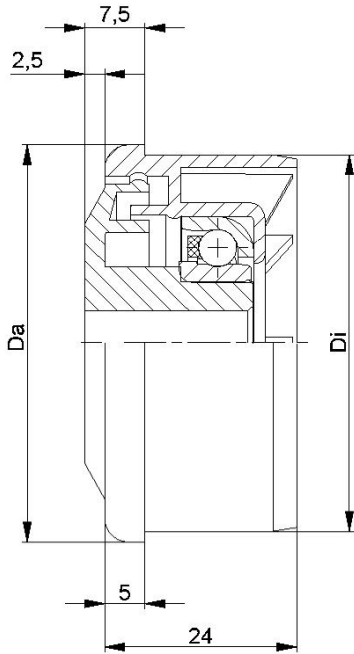

KTR-31			
Type	Di +0,2	Da	Load Rating C [daN]
KTR-50x1,5.31	47,3	49,9	25
KTR-50x2,8.31	44,6	49,9	25
KTR-60x1,5.31	57,3	59,9	25

Other dimensions on request!

- ☛ Housing: Plastic
- ☛ Single Labyrinth Seal: Plastic
- ☛ Bearing RL-31
 - ☛ Bearing Shell: 1.4301
 - ☛ Inner Race: 1.4305
 - ☛ Ball Cage: Plastic
 - ☛ Ball: 1.4301

Please note: the single labyrinth seal for axis 15 mm is delivered separately and has to be locked at assembly.

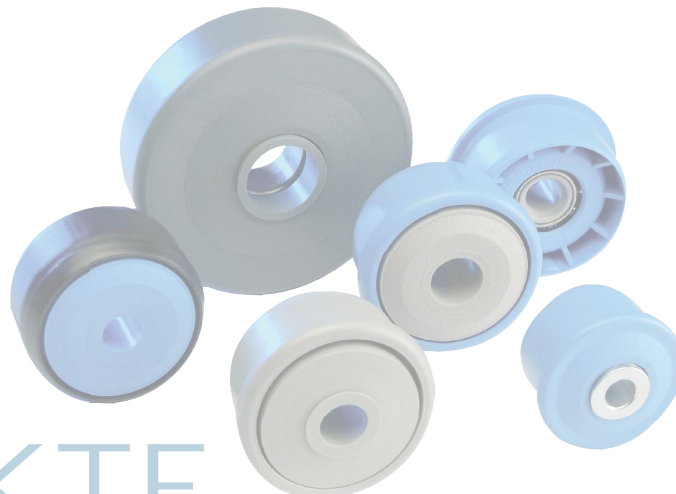

KTR-31

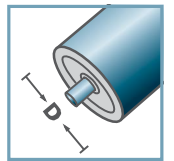

D [mm]
50 - 60

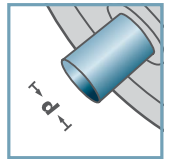

d [mm]
10; 12; 15; SW11



C [daN]
25

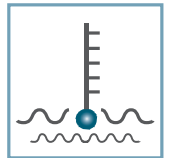

T [°C]
0° - 80°



Oil



Carton [pcs.]

ø50: 250
ø60: 200

KTR/KTE

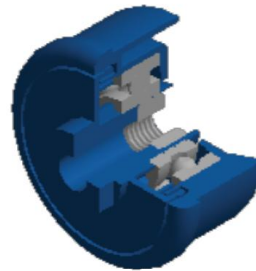
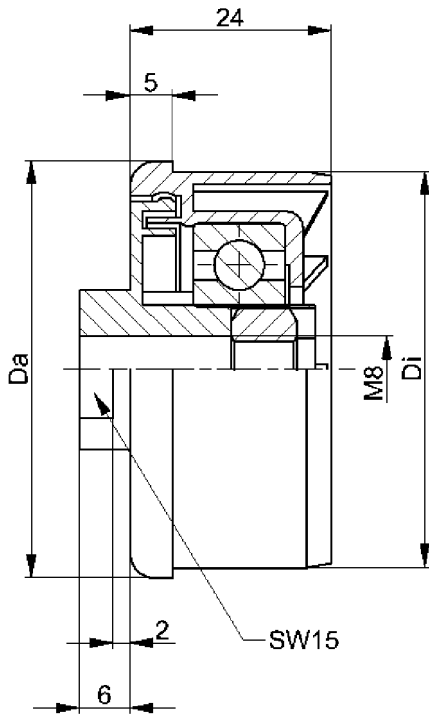

KTR-40.M8			
Type	Di +0,2	Da	Load Rating C [daN]
KTR-50x1,5.40	47,3	49,9	80

Other dimensions on request!

- Housing: Plastic
- Single Labyrinth Seal: Plastic
- Bearing 6202
- Hexagon Nut

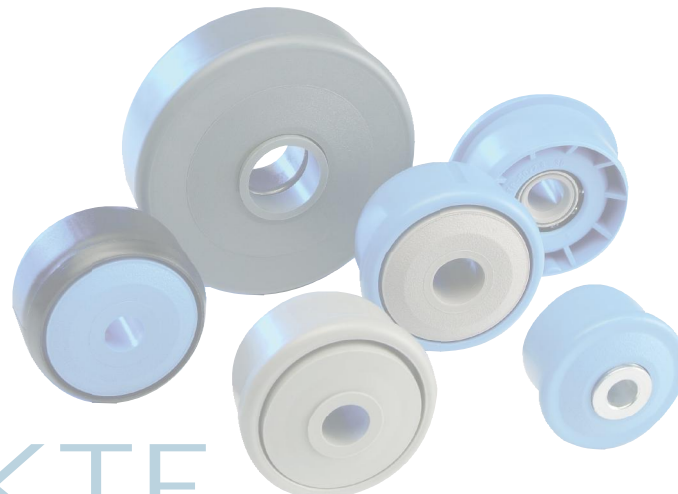

KTR-40.M8

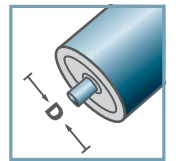

D [mm]
50

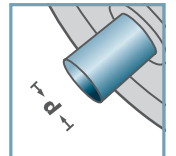

d [mm]
M8



C [daN]
80

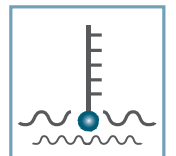

T [°C]
0° - 80°



EP 2



Carton [pcs.]

ø50: 250

KTR/KTE

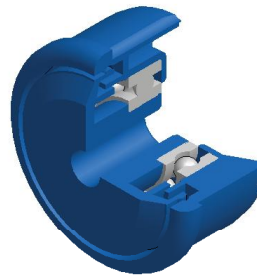
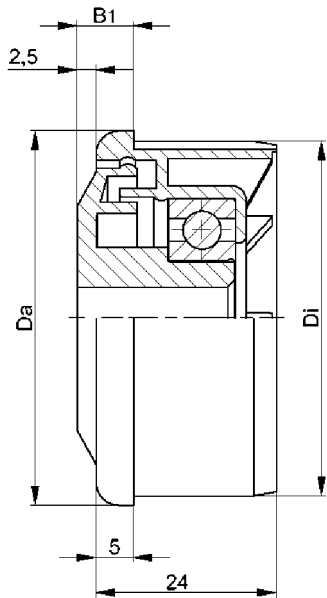

KTR-42

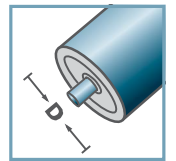

D [mm]
40 - 60

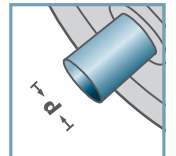

d [mm]
10; 12; 15; SW11



C [daN]
80; 120

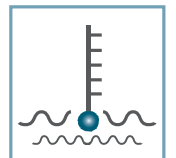

T [°C]
0° - 80°



EP 2



Carton [pcs.]

ø40: -
ø50: 250
ø60: 200

KTR-42				
Type	Di +0,25	Da	B1	Load Rating C [daN]
KTR-40x1,5.42	37,2	39,9	9,0	120
KTR-50x1,5.42	47,3	49,9	7,5	80
KTR-50x2,0.42	46,3	49,9	7,5	80
KTR-50x2,8.42	44,6	49,9	7,5	80
KTR-60x1,5.42	57,3	59,9	7,5	80
KTR-60x2,0.42	56,3	59,9	7,5	80
Other dimensions on request!				

- ☛ Housing: Plastic
- ☛ Single Labyrinth Seal: Plastic
- ☛ Bearing 6002

Please note: the single labyrinth seal for axis 15 mm is delivered separately and has to be locked at assembly.



KTR/KTE

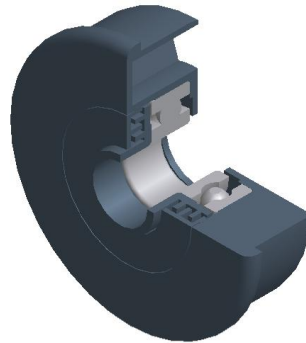
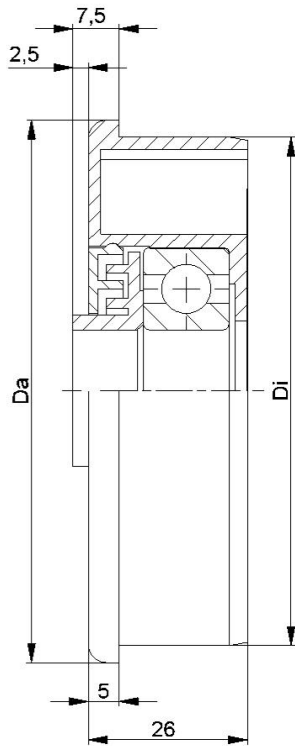

KTR-44			
Type	Di +0,2	Da	Load Rating C [daN]
KTR-89x3,0.44	83,3	88,9	150

Other dimensions on request!

- ☛ Housing: Plastic
- ☛ Inner Labyrinth Seal: Plastic
- ☛ Outer Labyrinth Seal: Plastic
- ☛ Bearing 6204

KTR-44

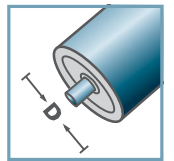

D [mm]
89

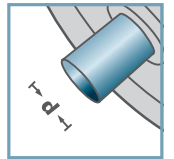

d [mm]
20



C [daN]
150

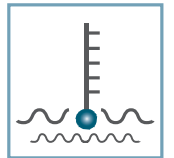

T [°C]
0° - 80°



EP 2



Carton [pcs.]

80

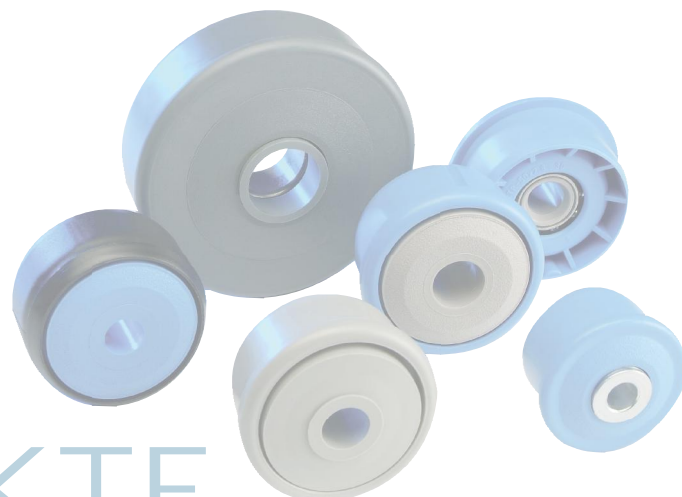

KTR/KTE

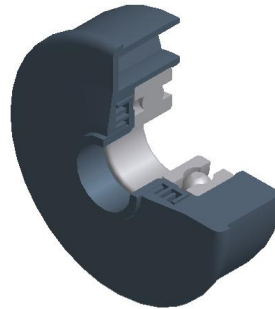
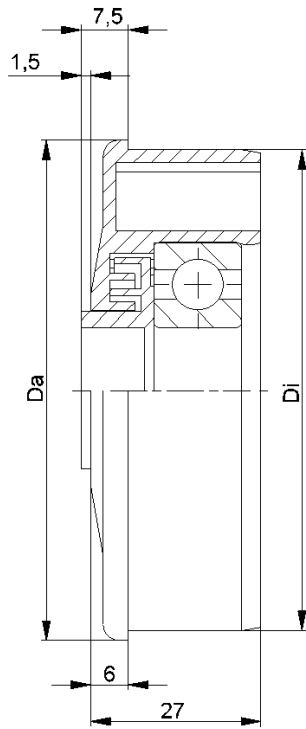

KTR-43/44			
Type	Di +0,2	Da	Load Rating C [daN]
KTR-63,5x2,9.43/.44	58,0	63,4	150
KTR-80x2,0.43/.44	76,4	79,9	150

Other dimensions on request!

- Housing: Plastic
- Multiple Labyrinth Seal: Plastic
- Bearing 6303/6204

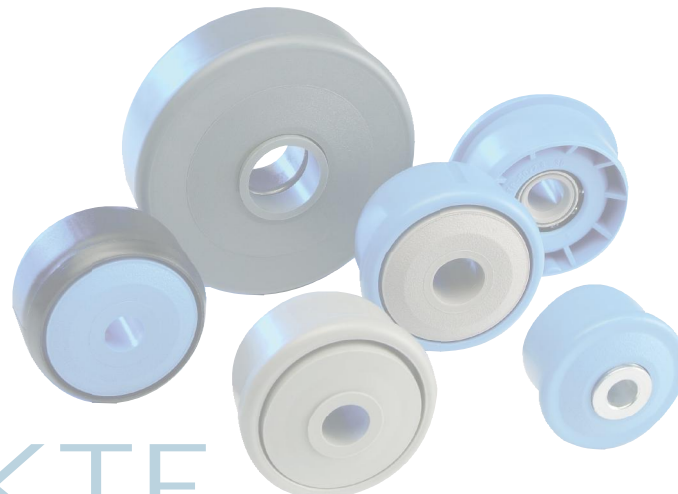

KTR-43/44

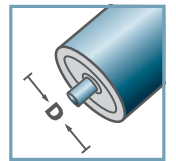

D [mm]
63,5 - 80

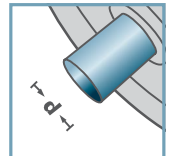

d [mm]
6303: 17
6204: 20



C [daN]
150

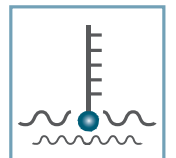

T [°C]
0° - 80°



EP 2



Carton [pcs.]

100

KTR/KTE

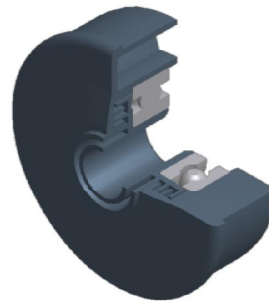
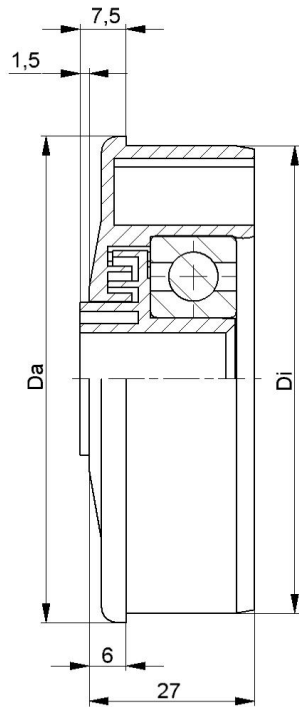

KTR-43/44

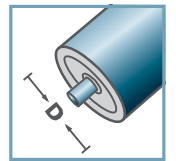

D [mm]
63,5 - 80

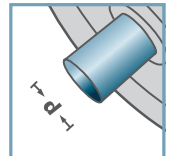

d [mm]
6303: 12
6204: 15



C [daN]
150

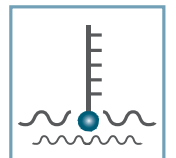

T [°C]
0° - 80°



EP 2



Carton [pcs.]

100

KTR-43/44			
Type	Di +0,2	Da	Load Rating C [daN]
KTR-63,5x2,9.43/.44	58,0	63,4	150
KTR-80x2,0.43/.44	76,4	79,9	150

Other dimensions on request!

- ☛ Housing: Plastic
- ☛ Multiple Labyrinth Seal: Plastic
- ☛ Bearing 6303/6204

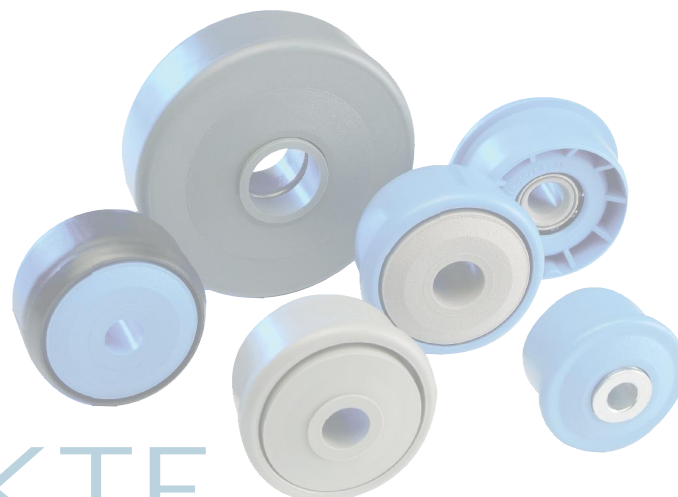

KTR/KTE

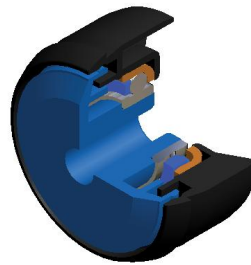
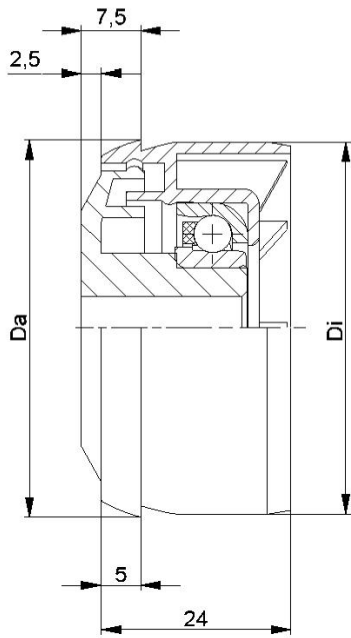

KTE-30			
Type	Di +0,3	Da	Load Rating C [daN]
KTE-50x1,5.30	47,1	47,9	80

Other dimensions on request!

- ☛ Housing: Plastic
- ☛ Single Labyrinth Seal: Plastic
- ☛ Bearing RL-30
 - ☛ Bearing Shell: Steel, Hardened
 - ☛ Inner Race: Steel, Hardened
 - ☛ Cage: Plastic
 - ☛ Ball: Steel

Please note: the single labyrinth seal for axis 15 mm is delivered separately and has to be locked at assembly.

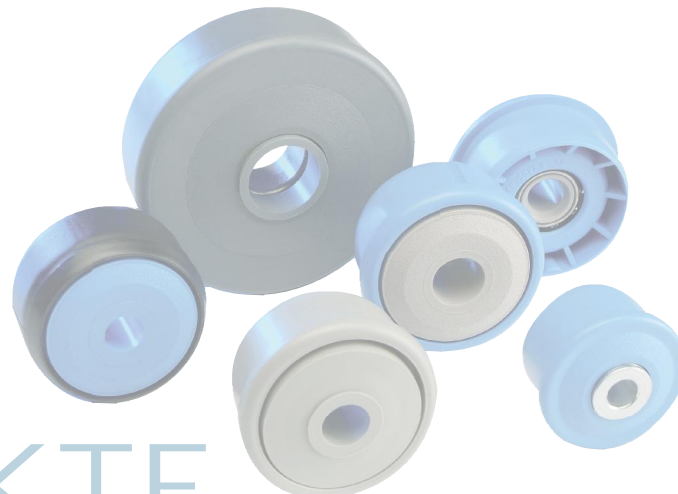

KTE-30

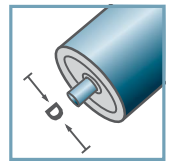

D [mm]
50

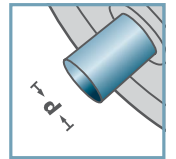

d [mm]
10; 12; 15; SW11



C [daN]
80

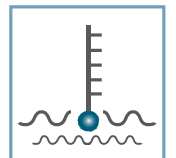

T [°C]
0° - 80°



Oil



Carton [pcs.]

250

KTR/KTE

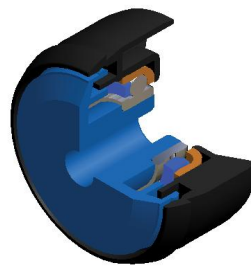
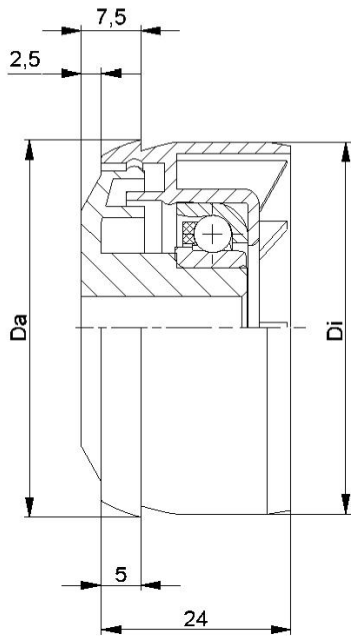

KTE-31			
Type	Di +0,3	Da	Load Rating C [daN]
KTE-50x1,5.31	47,1	47,9	25

Other dimensions on request!

- ☛ Housing: Plastic
- ☛ Single Labyrinth Seal: Plastic
- ☛ Bearing RL-31
 - ☛ Bearing Shell: 1.4301
 - ☛ Inner Race: 1.4305
 - ☛ Cage: Plastic
 - ☛ Ball: 1.4301

Please note: the single labyrinth seal for axis 15 mm is delivered separately and has to be locked at assembly.

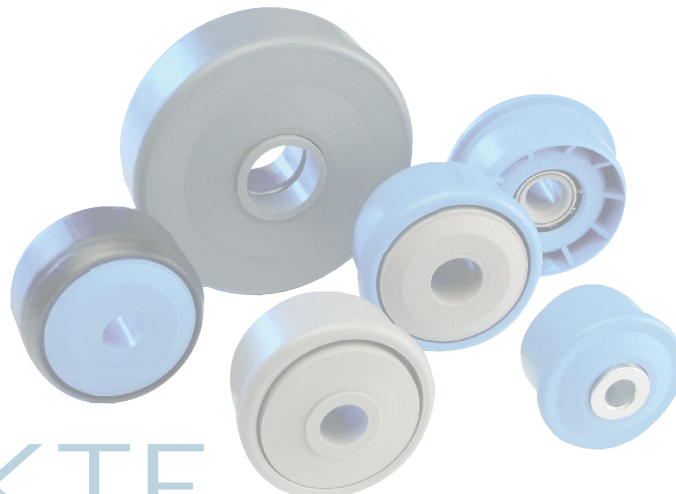

KTE-31

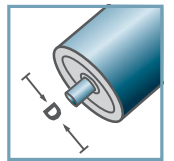

D [mm]
50

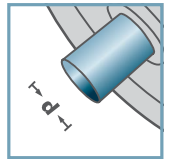

d [mm]
10; 12; 15; SW11



C [daN]
25

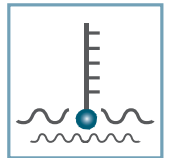

T [°C]
0° - 80°



Oil



Carton [pcs.]

250

KTR/KTE

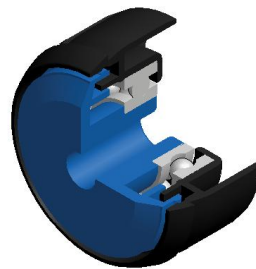
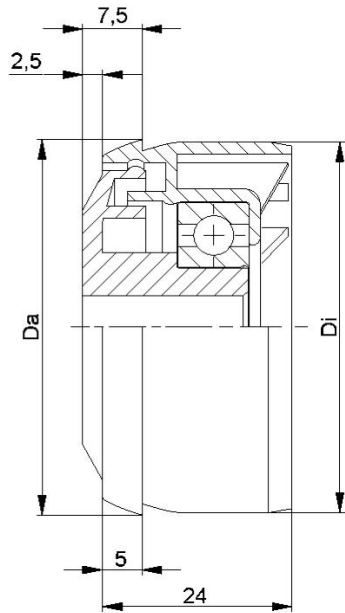

KTE-42			
Type	Di +0,3	Da	Load Rating C [daN]
KTE-50x1,5.42	47,1	47,9	80

Other dimensions on request!

- ☛ Housing: Plastic
- ☛ Single Labyrinth Seal: Plastic
- ☛ Bearing 6002

Please note: the single labyrinth seal for axis 15 mm is delivered separately and has to be locked at assembly.

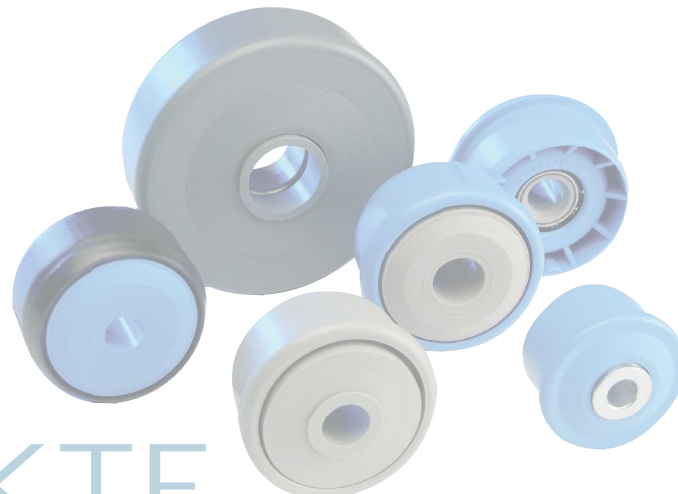

KTE-42

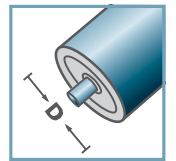

D [mm]
50

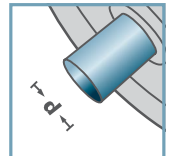

d [mm]
10; 12; 15; SW11



C [daN]
80

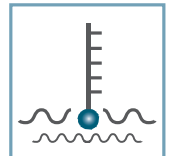

T [°C]
0° - 80°



EP 2



Carton [pcs.]

250

KTR/KTE